

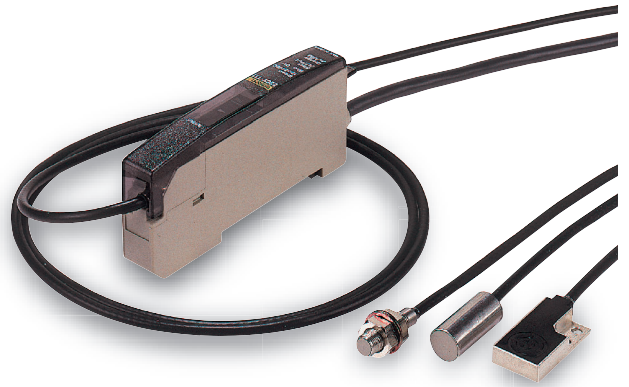

E2CY

Simple Teaching Function for Simple Sensitivity Adjustment. Easy-to-see Excess Gain Level Indicators.

- Detects aluminum, copper, and other non-ferrous metal objects.
- Compact Flat Sensors with a wide range of Sensing Heads.
- Eight easy-to-see excess gain level indicators.
- Fluororesin Sensor Head for applications requiring resistance to chemicals. (E2CY-C2AF)



 Be sure to read *Safety Precautions* on page 5.

Ordering Information

Sensors [Refer to *Dimensions* on page 6.]

Appearance	Stable sensing distance	Model
 Shielded	M5	E2CY-X1R5A 3M
	5.4 dia.	E2CY-C1R5A-1 3M
	8 dia.	E2CY-C2A 3M
	Flat	E2CY-V3A 3M
	8 dia.	E2CY-C2AF 3M

Amplifier Units

Output configuration	Model
DC 3-wire NPN open collector	E2CY-T11 2M

Note: The E2CY-C2AF is also available with a 5-m cable. Specify the cable length at the end of the model number (e.g., E2CY-C2AF 5M).

Ratings and Specifications

Sensors

Model		E2CY-X1R5A E2CY-C1R5A-1	E2CY-C2A(F)	E2CY-V3A
Item	Stable sensing distance	0 to 1.5 mm	0 to 2 mm	0 to 3 mm
Differential travel	10% max. of sensing distance with Amplifier Unit in FINE mode 10% max. of sensing distance with Amplifier Unit in NORM mode			
Detectable object	Non-ferrous metal			
Standard sensing object	Aluminum: 8 × 8 × 1 mm		Aluminum: 12 × 12 × 1 mm	
Response frequency *1	40 Hz min. with Amplifier Unit in FINE mode 100 Hz min. with Amplifier Unit in NORM mode			
Ambient temperature range	Operating: -10 to 55°C, Storage: -25 to 70°C, (with no icing or condensation)			
Ambient humidity range	Operating/Storage: 35% to 95% (with no condensation)			
Temperature influence	-10 to 55°C	±15% max. of sensing distance at 23°C	±10% max. of sensing distance at 23°C	±15% max. of sensing distance at 23°C
	0 to 40°C	±10% max. of sensing distance at 23°C*2		±10% max. of sensing distance at 23°C
Vibration resistance	Destruction: 10 to 500 Hz, 2-mm double amplitude or 150 m/s ² for 2 hours each in X, Y, and Z directions			
Shock resistance	Destruction: 500 m/s ² 3 times each in X, Y, and Z directions			
Degree of protection	IEC 60529 IP67			
Connection method	Pre-wired Models (High-frequency coaxial cable, Standard cable length: 3 m)			
Cable length compensation	0.5 to 5 m*3			
Weight (packed state)	Approx. 35 g			
Materials	Case	Stainless steel		Zinc die-cast
	Sensing surface	Heat-resistant ABS (E2CY-C2AF: Fluoresin)		
	Cable	Soft PVC (E2CY-C2AF: Fluoresin)		
	Clamping nut	Nickel-plated brass (E2CY-X1R5A only)		
	Toothed washer	Zinc-plated iron (E2CY-X1R5A only)		

*1. The average value when using the DC-switching control output on the Amplifier Unit.
Measurement conditions are as follows: standard sensing object, a distance of twice the standard sensing object, and a set distance of half the stable sensing distance.

*2. E2CY-C1R5A-1: ±15% max. of sensing distance at 23°C

*3. When extending the cable, use a 1.5D-2V (equivalent to JIS C 3501) cable with characteristic impedance of 50 Ω.

Amplifier Units

Item	Model	E2CY-T11
Power supply voltage (operating voltage range)	12 to 24 VDC (10 to 30 VDC), ripple (p-p): 10% max.	
Current consumption	40 mA max.	
Sensing distance adjustment range	10% max. of stable sensing distance	
Adjustment method	Teaching	
Control output	Load current	NPN open collector, 100 mA max. (30 VDC max.)
	Residual voltage	1 V max. (Load current: 100 mA, Cable length: 2 m)
Self-diagnostic output	NPN open collector, 100 mA max. (30 VDC max.)	
Operation mode	Changed with NO/NC switch.	
Protection circuits	Reverse polarity protection, Load short-circuit protection, Surge suppressor (control and diagnostic outputs)	
Teaching function monitor	Orange and green indicators (Also used for operation and excess gain level indicators.)	
Indicators	Operation indicator: Orange Excess gain level indicators: Green with sensing object approaching Orange with sensing object not approaching Fine-tuning indicator: Green	
Ambient temperature range	Operating: -10 to 55°C, Storage: -25 to 70°C, (with no icing or condensation)	
Ambient humidity range	Operating/Storage: 35% to 85% (with no condensation)	
Temperature influence	±10% max. of sensing distance at 23°C in the temperature range of -10 to 55°C	
Voltage influence	±1% max. of sensing distance in the rated voltage range ±10%	
Insulation resistance	50 MΩ min. (at 500 VDC) between current-carrying parts and case	
Dielectric strength	1,000 VAC, 50/60 Hz for 1 min between current-carrying parts and case	
Vibration resistance	Destruction: 10 to 150 Hz, 1.5-mm double amplitude or 100 m/s ² for 2 hours each in X, Y, and Z directions	
Shock resistance	Destruction: 300 m/s ² 3 times each in X, Y, and Z directions	
Degree of protection	IEC 60529 IP50 (with Sensor cable connected and protective cover attached)	
Connection method	Pre-wired Models (Standard cable length: 2 m)	
Cable length compensation	0.5 to 5 m for cable extension of free-cut length	
Weight (packed state)	Approx. 75 g	
Materials	Case	PBT
	Cover	Polycarbonate
Accessories	Mounting Bracket, instruction manual	

Engineering Data (Typical)

Sensing area

E2CY-X1R5A/E2CY-C1R5A-1

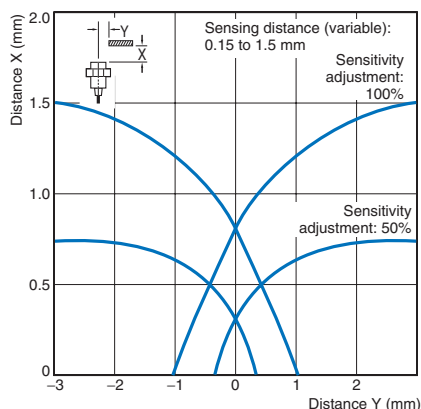

E2CY-C2A(F)

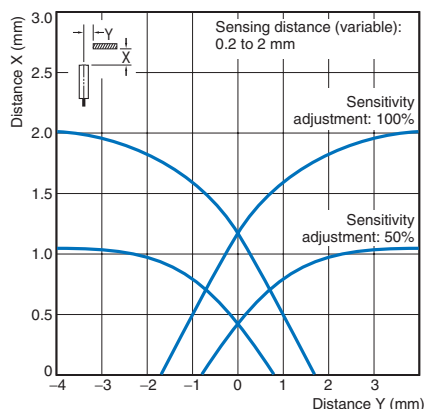

E2CY-V3A

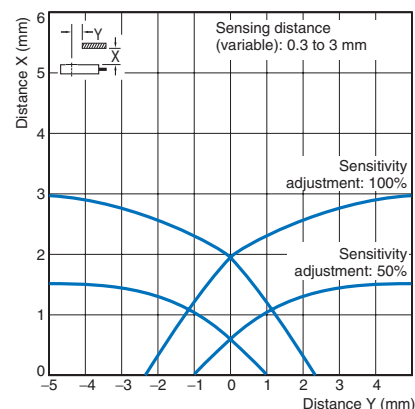

Influence of Sensing Object Size and Material

E2CY-X1R5A/E2CY-C1R5A-1

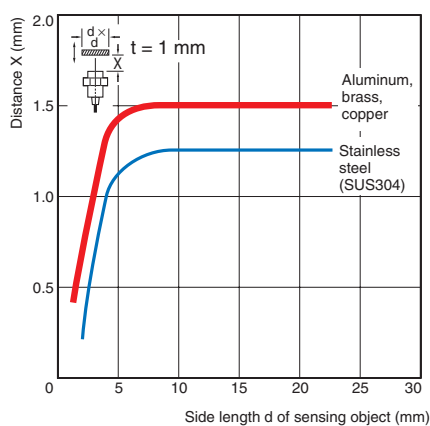

E2CY-C2A(F)

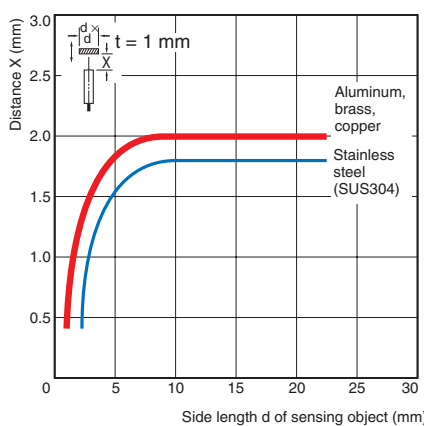

E2CY-V3A

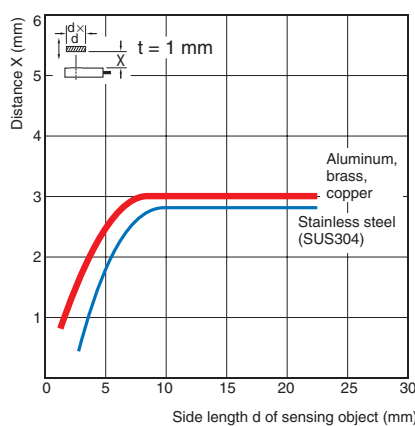

Temperature influence

E2CY-X1R5A/E2CY-C1R5A-1

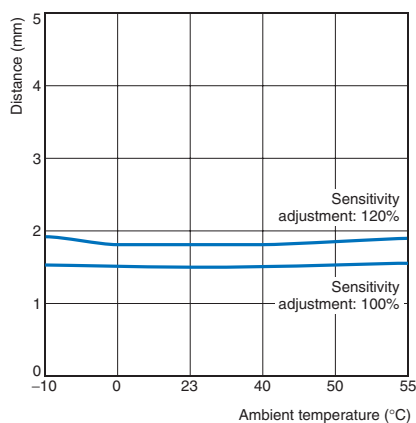

E2CY-C2A(F)

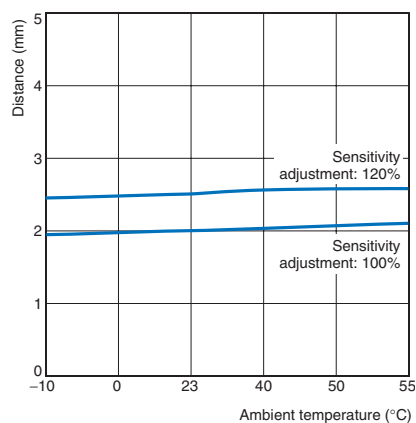

E2CY-V3A

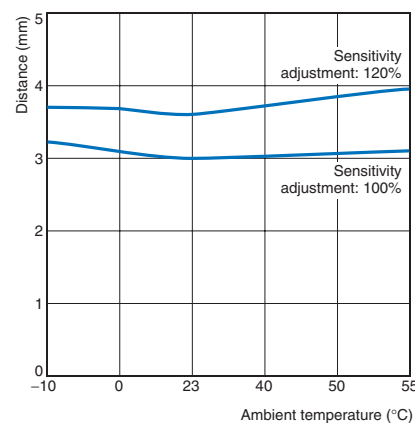

I/O Circuit Diagrams

Operation mode	Timing Chart	Output circuit
NO	<p>Sensing object Present</p> <p>Sensing object Not present</p> <p>Output transistor OFF</p> <p>Amplifier Unit ON</p> <p>Operation indicator (orange) OFF</p>	
NC	<p>Sensing object Present</p> <p>Sensing object Not present</p> <p>Output transistor ON</p> <p>Amplifier Unit ON</p> <p>Operation indicator (orange) OFF</p>	

Connection

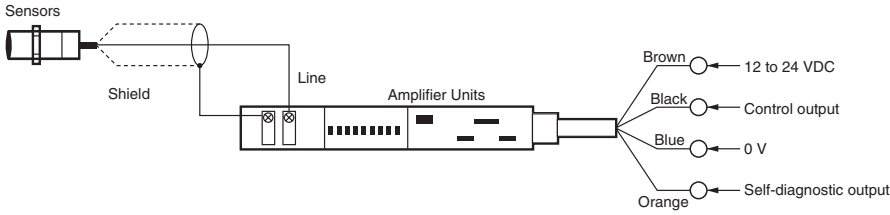

Nomenclature

Amplifier Units

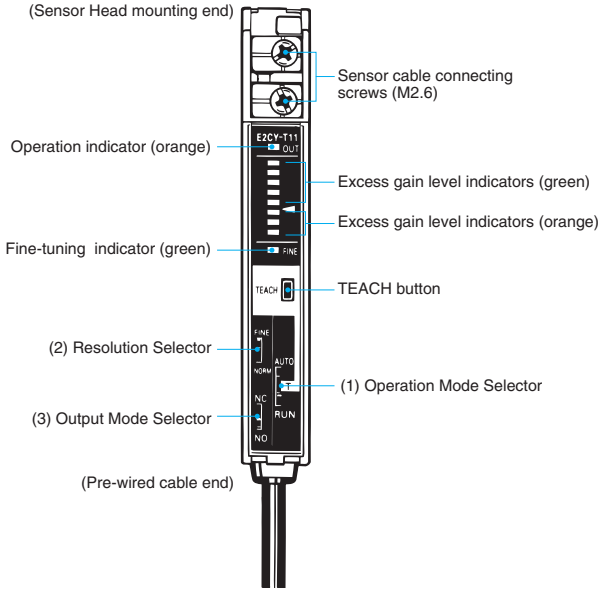

(1) Operation Mode Selector

AUTO Mode: The sensitivity is automatically adjusted within a range of approximately 80% to 110% of the rated sensing distance. Except for the E2CY-C1R5A-1, which is adjusted within approximately 60% to 110% of the rated sensing distance.

T Mode: This mode is used when adjusting the sensitivity of the Sensor. (The output transistor does not operate in this mode.)

RUN Mode: This mode is used for the normal operation of the Sensor.

(2) Resolution Selector

If the E2CY often has a teaching error when detecting fine differences, set the resolution selector to FINE. The response speed will drop but improvement in the sensing precision of the E2CY can be expected.

(3) Output Mode Selector

Used to select the transistor mode of the NPN open-collector output.

NO: Normally open output (Output transistor will turn ON if a sensing object is present.)

NC: Normally closed output (Output transistor will turn ON if a sensing object is not present.)

Indicators

Operation Indicator (Orange)

The operating indicator will turn ON when the control output is ON.

Excess Gain Level Indicators (Green and Orange)

The excess gain level indicators will be ON according to the distance of the sensing object as shown at the right.

Excess Gain Level Indicators

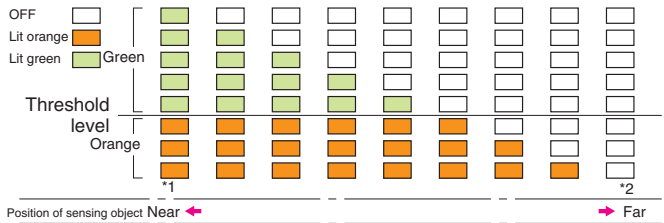

*1. All indicators will be ON if the sensing object is at a position of approximately 80% of the preset sensing distance.
 *2. All indicators will be OFF if the sensing object is at a position of approximately 110% of the reset distance.

Safety Precautions

Refer to *Warranty and Limitations of Liability*.

⚠ WARNING

This product is not designed or rated for ensuring safety of persons either directly or indirectly. Do not use it for such purposes.



Precautions for Correct Use

Do not use the Encoder under ambient conditions that exceed the ratings.

● Design

Influence of Surrounding Metal

When mounting the Sensor within a metal panel, ensure that the clearances given in the following table are maintained. Failure to maintain these distances may cause deterioration in the performance of the Sensor.

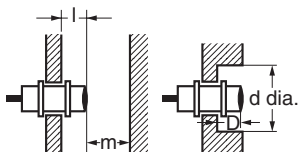

Influence of Surrounding Metal (Unit: mm)

Model	Item	l	d	D	m
E2CY-X1R5A/ E2CY-C1R5A-1	0	0	5	0	9
E2CY-C2A(F)			8		15
E2CY-V3A			12		18

The E2CY-V3A can be embedded in metal with the sensing surface at the same level as the metal surface.

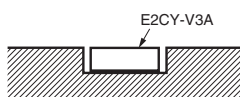

Mutual Interference

When installing Sensors face-to-face or side-by-side, ensure that the minimum distances given in the following table are maintained.

Mutual Interference (Unit: mm)

Model	Item	A	B
E2CY-X1R5A E2CY-C1R5A-1	20	15	15
E2CY-C2A(F)			
E2CY-V3A	30	12	12

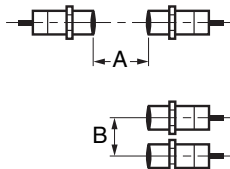

Effects of a High-frequency Electromagnetic Field

If the Sensor is located near a device that generates high frequencies or a transceiver, it may be affected by such a device and malfunctions may occur.

● Mounting

- Do not use excessive force when tightening the nuts on the E2CY-□.
 - A toothed washer must be used with the nut.



Model	Torque
E2CY-X1R5A	1 N·m

Note: The above leeways in tighten torque assume that a toothed washer is being used.

- Mounting Unthreaded Cylindrical Models

When using a set screw, tighten it to a torque of 0.2 N·m max.

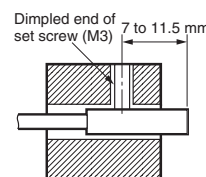

● Adjustment

Power ON

The Sensor is ready to sense an object within 50 ms after turning the power ON.

If the load and Sensor are connected to different power supplies, always turn ON the Sensor power first.

Teaching

Make sure that the Sensor is in operating condition before making sensitivity adjustments.

Processing the Sensor Cable Ends

When cutting or extending the cable, the end of the Sensor cable connected to the E2CY-□ must be processed as shown in the following illustration.

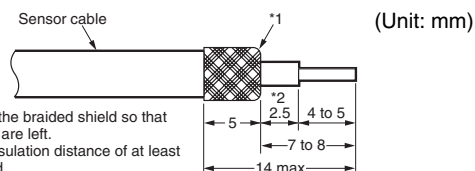

- *1. Be sure to turn over the braided shield so that none of its thin wires are left.
- *2. Make sure that an insulation distance of at least 2.5 mm is maintained.

Self-diagnostic Function

The self-diagnostic output transistor will turn ON in the following cases.

(1) Sensor Open Circuit:

Output will turn ON 105 ms after the Sensor circuit opens.

(2) Sensor Short Circuit:

Output will turn ON 105 ms after the Sensor circuit shorts.

(3) Control Output Short Circuit:

Output will turn ON when both ends of the control output (load) are shorted and an overcurrent flows.

(4) Internal Memory Error:

Output will turn ON when the teaching conditions cannot be recorded in internal memory when power is turned ON in RUN or TEACH mode.

Dimensions

Tolerance class IT16 applies to dimensions in this data sheet unless otherwise specified.

Sensors

E2CY-X1R5A

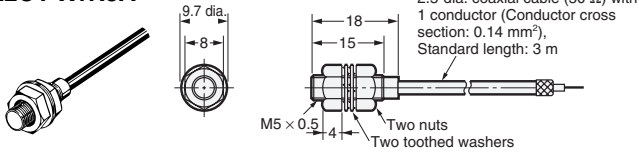

E2CY-C1R5A-1

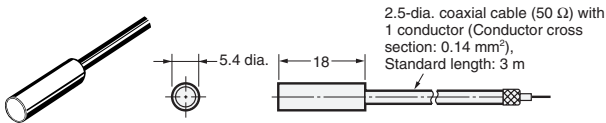

E2CY-C2A(F)

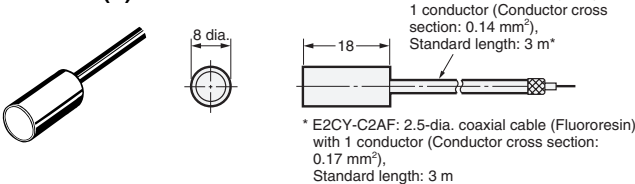

E2CY-V3A

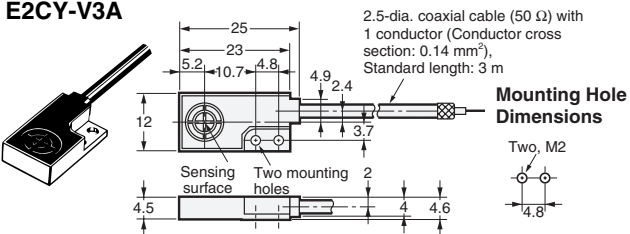

Amplifier Units

E2CY-T11

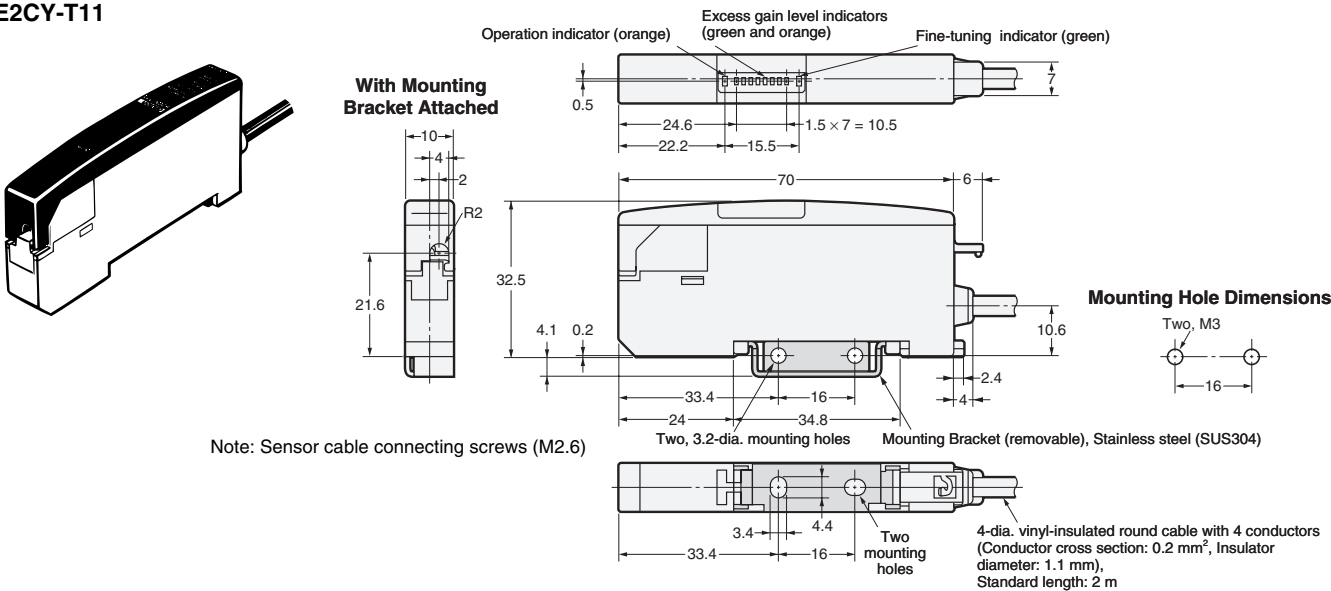

Read and Understand This Catalog

Please read and understand this catalog before purchasing the products. Please consult your OMRON representative if you have any questions or comments.

Warranty and Limitations of Liability

WARRANTY

OMRON's exclusive warranty is that the products are free from defects in materials and workmanship for a period of one year (or other period if specified) from date of sale by OMRON.

OMRON MAKES NO WARRANTY OR REPRESENTATION, EXPRESS OR IMPLIED, REGARDING NON-INFRINGEMENT, MERCHANTABILITY, OR FITNESS FOR PARTICULAR PURPOSE OF THE PRODUCTS. ANY BUYER OR USER ACKNOWLEDGES THAT THE BUYER OR USER ALONE HAS DETERMINED THAT THE PRODUCTS WILL SUITABLY MEET THE REQUIREMENTS OF THEIR INTENDED USE. OMRON DISCLAIMS ALL OTHER WARRANTIES, EXPRESS OR IMPLIED.

LIMITATIONS OF LIABILITY

OMRON SHALL NOT BE RESPONSIBLE FOR SPECIAL, INDIRECT, OR CONSEQUENTIAL DAMAGES, LOSS OF PROFITS OR COMMERCIAL LOSS IN ANY WAY CONNECTED WITH THE PRODUCTS, WHETHER SUCH CLAIM IS BASED ON CONTRACT, WARRANTY, NEGLIGENCE, OR STRICT LIABILITY.

In no event shall the responsibility of OMRON for any act exceed the individual price of the product on which liability is asserted.

IN NO EVENT SHALL OMRON BE RESPONSIBLE FOR WARRANTY, REPAIR, OR OTHER CLAIMS REGARDING THE PRODUCTS UNLESS OMRON'S ANALYSIS CONFIRMS THAT THE PRODUCTS WERE PROPERLY HANDLED, STORED, INSTALLED, AND MAINTAINED AND NOT SUBJECT TO CONTAMINATION, ABUSE, MISUSE, OR INAPPROPRIATE MODIFICATION OR REPAIR.

Application Considerations

SUITABILITY FOR USE

OMRON shall not be responsible for conformity with any standards, codes, or regulations that apply to the combination of products in the customer's application or use of the products.

At the customer's request, OMRON will provide applicable third party certification documents identifying ratings and limitations of use that apply to the products. This information by itself is not sufficient for a complete determination of the suitability of the products in combination with the end product, machine, system, or other application or use.

The following are some examples of applications for which particular attention must be given. This is not intended to be an exhaustive list of all possible uses of the products, nor is it intended to imply that the uses listed may be suitable for the products:

- Outdoor use, uses involving potential chemical contamination or electrical interference, or conditions or uses not described in this catalog.
- Nuclear energy control systems, combustion systems, railroad systems, aviation systems, medical equipment, amusement machines, vehicles, safety equipment, and installations subject to separate industry or government regulations.
- Systems, machines, and equipment that could present a risk to life or property.

Please know and observe all prohibitions of use applicable to the products.

NEVER USE THE PRODUCTS FOR AN APPLICATION INVOLVING SERIOUS RISK TO LIFE OR PROPERTY WITHOUT ENSURING THAT THE SYSTEM AS A WHOLE HAS BEEN DESIGNED TO ADDRESS THE RISKS, AND THAT THE OMRON PRODUCTS ARE PROPERLY RATED AND INSTALLED FOR THE INTENDED USE WITHIN THE OVERALL EQUIPMENT OR SYSTEM.

PROGRAMMABLE PRODUCTS

OMRON shall not be responsible for the user's programming of a programmable product, or any consequence thereof.

Disclaimers

CHANGE IN SPECIFICATIONS

Product specifications and accessories may be changed at any time based on improvements and other reasons.

It is our practice to change model numbers when published ratings or features are changed, or when significant construction changes are made. However, some specifications of the products may be changed without any notice. When in doubt, special model numbers may be assigned to fix or establish key specifications for your application on your request. Please consult with your OMRON representative at any time to confirm actual specifications of purchased products.

DIMENSIONS AND WEIGHTS

Dimensions and weights are nominal and are not to be used for manufacturing purposes, even when tolerances are shown.

PERFORMANCE DATA

Performance data given in this catalog is provided as a guide for the user in determining suitability and does not constitute a warranty. It may represent the result of OMRON's test conditions, and the users must correlate it to actual application requirements. Actual performance is subject to the OMRON Warranty and Limitations of Liability.

ERRORS AND OMISSIONS

The information in this document has been carefully checked and is believed to be accurate; however, no responsibility is assumed for clerical, typographical, or proofreading errors, or omissions.

2008.11

In the interest of product improvement, specifications are subject to change without notice.

OMRON Corporation
Industrial Automation Company

<http://www.ia.omron.com/>

(c)Copyright OMRON Corporation 2008 All Right Reserved.